

## Bottom labeling

# The 552C, the foundation for your success

In bottom labeling in particular, it is essential to minimize setup times with as little effort as possible.

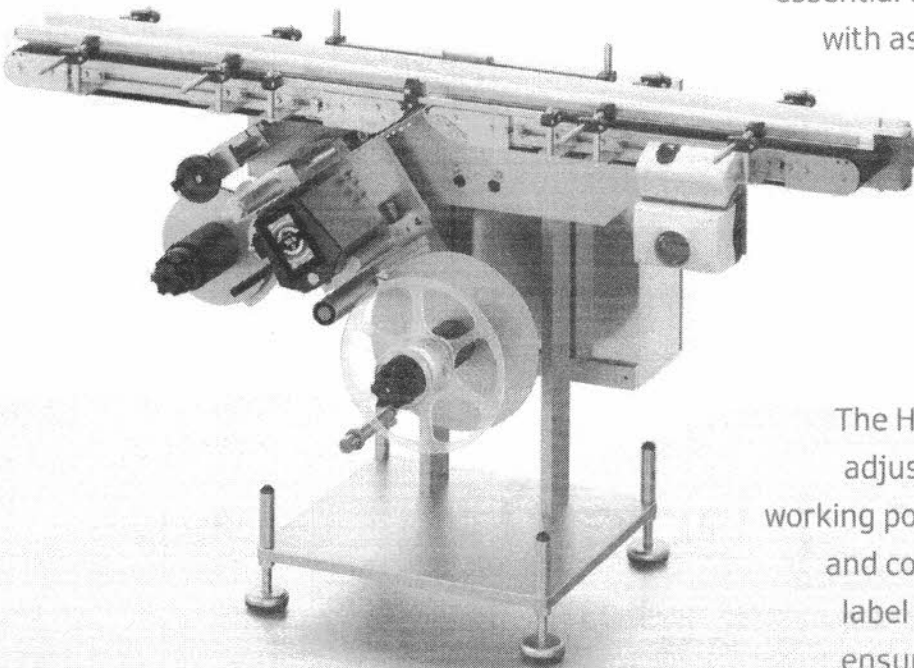

The HERMA 500 can be easily adjusted to its insertion and working position allowing for quick and convenient changeover of label reels. The conveyor belt ensures the label application so the turning of the products is no longer necessary.



552C on video

## Highlights

By choosing the new HERMA 500, you can expect top performance in every aspect. Highlights of this technological flagship include a touchscreen with an innovative menu navigation and state-of-the-art interfaces.

For automatic label detection the FS03 sensor of HERMA senses the last label on the peel plate, thereby ensuring maximum precision.

Thanks to their modular design, the labeling machines are available at very short notice.

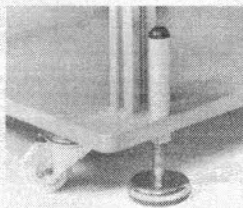
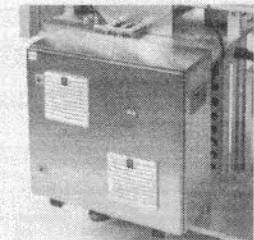
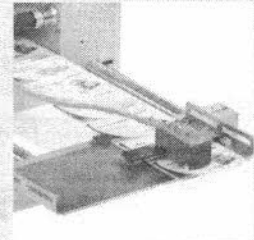
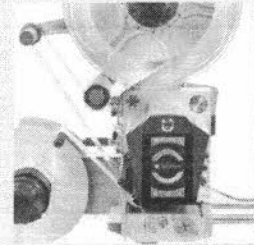

## Useful options

If required, the machines are available as moveable versions, giving you the flexibility to place them exactly where they are needed.

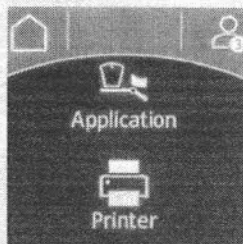

A hot-foil printer can be easily integrated to allow for variable data printing.

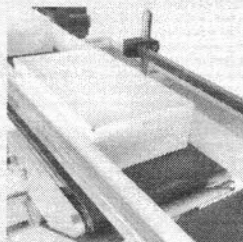

The machines are available with various conveyor belt dimensions, making them suitable for a wide range of applications.